

SMBG AND SMBJ5.0 THRU 170CA

SURFACE MOUNT TRANSZORB™ TRANSIENT VOLTAGE SUPPRESSOR

Stand-off Voltage - 5.0 to 170 Volts Peak Pulse Power - 600 Watts

DO-214AA
MODIFIED J-BEND

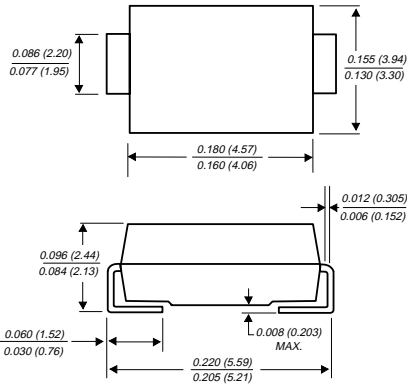

DO-215AA
GULL WING

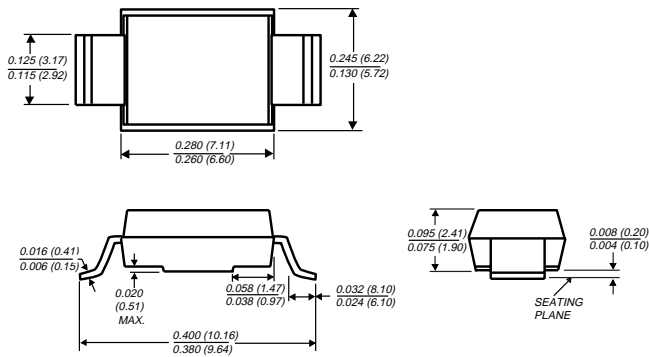

Dimensions in inches and (millimeters)

FEATURES

- ◆ Plastic package has Underwriters Laboratory Flammability Classification 94V-0
- ◆ For surface mounted applications in order to optimize board space
- ◆ Low profile package
- ◆ Built-in strain relief
- ◆ Glass passivated junction
- ◆ Low incremental surge resistance
- ◆ 600W peak pulse power capability with a 10/1000μs waveform, repetition rate (duty cycle): 0.01%
- ◆ Excellent clamping capability
- ◆ Fast response time: typically less than 1.0ps from 0 volts to $V_{(BR)}$ for unidirectional and 5.0ns for bidirectional types
- ◆ For devices with $V_{(BR)} \geq 10V$, I_D are typically less than 1.0μA
- ◆ High temperature soldering guaranteed: 250°C/10 seconds at terminals



MECHANICAL DATA

Case: JEDEC DO214AA / DO215AA molded plastic body over passivated junction

Terminals: Solder plated, solderable per MIL-STD-750, Method 2026

Polarity: For unidirectional types the color band denotes the cathode, which is positive with respect to the anode under normal TVS operation

Mounting Position: Any

Weight: 0.003 ounces, 0.093 gram

DEVICES FOR BIDIRECTIONAL APPLICATIONS

For bidirectional use suffix C or CA for types SMB-5.0 thru SMB-170 (eg. SMBG5.0C, SMBJ170CA).

Electrical characteristics apply in both directions

MAXIMUM RATINGS AND ELECTRICAL CHARACTERISTICS

Ratings at 25°C ambient temperature unless otherwise specified.

	SYMBOLS	VALUE	UNITS
Peak pulse power dissipation with a 10/1000μs waveform (NOTES 1, 2, FIG. 1)	PPPM	Minimum 600	Watts
Peak pulse current with a 10/1000μs waveform (NOTE 1)	IPPM	SEE TABLE 1	Amps
Peak forward surge current 8.3ms single half sine-wave superimposed on rated load (JEDEC Method) (NOTES 2, 3) - unidirectional only	IFSM	100.0	Amps
Maximum instantaneous forward voltage at 50A (NOTE 3) unidirectional only	V _F	3.5	Volts
Operating junction and storage temperature range	T _J , T _{STG}	-55 to +150	°C

NOTES:

- (1) Non-repetitive current pulse, per Fig.3 and derated above $T_A=25^\circ\text{C}$ per Fig. 2
- (2) Mounted on 0.2 x 0.2" (5.0 x 5.0mm) copper pads to each terminal
- (3) Measured on 8.3ms single half sine-wave. For uni-directional devices only.

ELECTRICAL CHARACTERISTICS (TA=25°C unless otherwise noted) TABLE 1

Device Type Gull Wing Lead	Device Type Modified "J" Bend Lead	Device Marking Code		Breakdown Voltage V(BR)(Volts) (NOTE 1) (MIN /MAX)	Test Current at IT (mA)	Stand-off Voltage VWM (Volts)	Maximum Reverse Leakage Id at VWM (µA) (NOTE 3)	Maximum Peak Pulse Surge Current IPPM (NOTE 2) (Amps)	Maximum Clamping Voltage at IPPM Vc (Volts)
		UNI	BI						
SMBG5.0	SMBJ5.0	KD	KD	6.40 / 7.82	10	5.0	800	62.5	9.6
SMBG5.0A	SMBJ5.0A	KE	KE	6.40 / 7.07	10	5.0	800	65.2	9.2
SMBG6.0	SMBJ6.0	KF	KF	6.67 / 8.15	10	6.0	800	52.6	11.4
SMBG6.0A	SMBJ6.0A	KG	KG	6.67 / 7.37	10	6.0	800	58.3	10.3
SMBG6.5	SMBJ6.5	KH	AH	7.22 / 8.82	10	6.5	500	48.8	12.3
SMBG6.5A	SMBJ6.5A	KK	AK	7.22 / 7.98	10	6.5	500	53.6	11.2
SMBG7.0	SMBJ7.0	KL	KL	7.78 / 9.51	10	7.0	200	45.1	13.3
SMBG7.0A	SMBJ7.0A	KM	KM	7.78 / 8.60	10	7.0	200	50.0	12.0
SMBG7.5	SMBJ7.5	KN	AN	8.33 / 10.2	1.0	7.5	100	42.0	14.3
SMBG7.5A	SMBJ7.5A	KP	AP	8.33 / 9.21	1.0	7.5	100	46.5	12.9
SMBG8.0	SMBJ8.0	KQ	AQ	8.89 / 10.9	1.0	8.0	50	40.0	15.0
SMBG8.0A	SMBJ8.0A	KR	AR	8.89 / 9.83	1.0	8.0	50	44.1	13.6
SMBG8.5	SMBJ8.5	KS	AS	9.44 / 11.5	1.0	8.5	20	37.7	15.9
SMBG8.5A	SMBJ8.5A	KT	AT	9.44 / 10.4	1.0	8.5	20	41.7	14.4
SMBG9.0	SMBJ9.0	KU	AU	10.0 / 12.2	1.0	9.0	10	35.5	16.9
SMBG9.0A	SMBJ9.0A	KV	AV	10.0 / 11.1	1.0	9.0	10	39.0	15.4
SMBG10	SMBJ10	KW	AW	11.1 / 13.6	1.0	10	5.0	31.9	18.8
SMBG10A	SMBJ10A	KX	AX	11.1 / 12.3	1.0	10	5.0	35.3	17.0
SMBG11	SMBJ11	KY	KY	12.2 / 14.9	1.0	11	5.0	29.9	20.1
SMBG11A	SMBJ11A	KZ	KZ	12.2 / 13.5	1.0	11	5.0	33.0	18.2
SMBG12	SMBJ12	LD	BD	13.3 / 16.3	1.0	12	5.0	27.3	22.0
SMBG12A	SMBJ12A	LE	BE	13.3 / 14.7	1.0	12	5.0	30.2	19.9
SMBG13	SMBJ13	LF	LF	14.4 / 17.6	1.0	13	5.0	25.2	23.8
SMBG13A	SMBJ13A	LG	LG	14.4 / 15.9	1.0	13	5.0	27.9	21.5
SMBG14	SMBJ14	LH	BH	15.6 / 19.1	1.0	14	5.0	23.3	25.8
SMBG14A	SMBJ14A	LK	BK	15.6 / 17.2	1.0	14	5.0	25.9	23.2
SMBG15	SMBJ15	LL	BL	16.7 / 20.4	1.0	15	5.0	22.3	26.9
SMBG15A	SMBJ15A	LM	BM	16.7 / 18.5	1.0	15	5.0	24.6	24.4
SMBG16	SMBJ16	LN	LN	17.8 / 21.8	1.0	16	5.0	20.8	28.8
SMBG16A	SMBJ16A	LP	LM	17.8 / 19.7	1.0	16	5.0	23.1	26.0
SMBG17	SMBJ17	LQ	LQ	18.9 / 23.1	1.0	17	5.0	19.7	30.5
SMBG17A	SMBJ17A	LR	LR	18.9 / 20.9	1.0	17	5.0	21.7	27.6
SMBG18	SMBJ18	LS	BS	20.0 / 24.4	1.0	18	5.0	18.6	32.2
SMBG18A	SMBJ18A	LT	BT	20.0 / 22.1	1.0	18	5.0	20.5	29.2
SMBG20	SMBJ20	LU	LU	22.2 / 27.1	1.0	20	5.0	16.8	35.8
SMBG20A	SMBJ20A	LV	LV	22.2 / 24.5	1.0	20	5.0	18.5	32.4
SMBG22	SMBJ22	LW	BW	24.4 / 29.8	1.0	22	5.0	15.2	39.4
SMBG22A	SMBJ22A	LX	BX	24.4 / 26.9	1.0	22	5.0	16.9	35.5
SMBG24	SMBJ24	LY	BY	26.7 / 32.6	1.0	24	5.0	14.0	43.0
SMBG24A	SMBJ24A	LZ	BZ	26.7 / 29.5	1.0	24	5.0	15.4	38.9
SMBG26	SMBJ26	MD	CD	28.9 / 35.3	1.0	26	5.0	12.9	46.6
SMBG26A	SMBJ26A	ME	CE	28.9 / 31.9	1.0	26	5.0	14.3	42.1
SMBG28	SMBJ28	MF	MF	31.1 / 38.0	1.0	28	5.0	12.0	50.0
SMBG28A	SMBJ28A	MG	MG	31.1 / 34.4	1.0	28	5.0	13.2	45.4
SMBG30	SMBJ30	MH	CH	33.3 / 40.7	1.0	30	5.0	11.2	53.5
SMBG30A	SMBJ30A	MK	CK	33.3 / 36.8	1.0	30	5.0	12.4	48.4
SMBG33	SMBJ33	ML	CL	36.7 / 44.9	1.0	33	5.0	10.2	59.0
SMBG33A	SMBJ33A	MM	CM	36.7 / 40.6	1.0	33	5.0	11.3	53.3
SMBG36	SMBJ36	MN	CN	40.0 / 48.9	1.0	36	5.0	9.3	64.3
SMBG36A	SMBJ36A	MP	CP	40.0 / 44.2	1.0	36	5.0	10.3	58.1
SMBG40	SMBJ40	MQ	CQ	44.4 / 54.3	1.0	40	5.0	8.4	71.4
SMBG40A	SMBJ40A	MR	CR	44.4 / 49.1	1.0	40	5.0	9.3	64.5
SMBG43	SMBJ43	MS	CS	47.8 / 58.4	1.0	43	5.0	7.8	76.7
SMBG43A	SMBJ43A	MT	CT	47.8 / 52.8	1.0	43	5.0	8.6	69.4
SMBG45	SMBJ45	MU	MU	50.0 / 61.1	1.0	45	5.0	7.5	80.3
SMBG45A	SMBJ45A	MV	MV	50.0 / 55.3	1.0	45	5.0	8.3	72.7
SMBG48	SMBJ48	MW	MW	53.3 / 65.1	1.0	48	5.0	7.0	85.5
SMBG48A	SMBJ48A	MX	MX	53.3 / 58.9	1.0	48	5.0	7.8	77.4
SMBG51	SMBJ51	MY	MY	56.7 / 69.3	1.0	51	5.0	6.6	91.1
SMBG51A	SMBJ51A	MZ	MZ	56.7 / 62.7	1.0	51	5.0	7.3	82.4

ELECTRICAL CHARACTERISTICS (T_A = 25°C unless otherwise noted) TABLE 1 (Cont'd)

Device Type Gull Wing Lead	Device Type Modified "J" Bend Lead	Device Marking Code		Breakdown Voltage V _(BR) (Volts) (NOTE 1) (Min / Max)	Test Current at I _T (mA)	Stand-off Voltage V _{WM} (Volts)	Maximum Reverse Leakage I _D at V _{WM} (μA)(NOTE 3)	Maximum Peak Pulse Surge Current I _{PPM} (NOTE 2) (Amps)	Maximum Clamping Voltage at I _{PPM} V _C (Volts)
		UNI	BI						
SMBG54	SMBJ54	ND	ND	60.0 / 73.3	1.0	54	5.0	6.2	96.3
SMBG54A	SMBJ54A	NE	NE	60.0 / 66.3	1.0	54	5.0	6.9	87.1
SMBG58	SMBJ58	NF	NF	64.4 / 78.7	1.0	58	5.0	5.8	103
SMBG58A	SMBJ58A	NG	NG	64.4 / 71.2	1.0	58	5.0	6.4	93.6
SMBG60	SMBJ60	NH	NH	66.7 / 81.5	1.0	60	5.0	5.6	107
SMBG60A	SMBJ60A	NK	NK	66.7 / 73.7	1.0	60	5.0	6.2	96.8
SMBG64	SMBJ64	NL	NL	71.1 / 86.9	1.0	64	5.0	5.3	114
SMBG64A	SMBJ64A	NM	NM	71.1 / 78.6	1.0	64	5.0	5.8	103
SMBG70	SMBJ70	NN	NN	77.8 / 95.1	1.0	70	5.0	4.8	125
SMBG70A	SMBJ70A	NP	NP	77.8 / 86.0	1.0	70	5.0	5.3	113
SMBG75	SMBJ75	NQ	NQ	83.3 / 102	1.0	75	5.0	4.5	134
SMBG75A	SMBJ75A	NR	NR	83.3 / 92.1	1.0	75	5.0	5.0	121
SMBG78	SMBJ78	NS	NS	86.7 / 106	1.0	78	5.0	4.3	139
SMBG78A	SMBJ78A	NT	NT	86.7 / 95.8	1.0	78	5.0	4.8	126
SMBG85	SMBJ85	NU	NU	94.4 / 115	1.0	85	5.0	4.0	151
SMBG85A	SMBJ85A	NV	NV	94.4 / 104	1.0	85	5.0	4.4	137
SMBG90	SMBJ90	NW	NW	100 / 122	1.0	90	5.0	3.8	160
SMBG90A	SMBJ90A	NX	NX	100 / 111	1.0	90	6.0	4.1	146
SMBG100	SMBJ100	NY	NY	111 / 136	1.0	100	5.0	3.4	179
SMBG100A	SMBJ100A	NZ	NZ	111 / 123	1.0	100	5.0	3.7	162
SMBG110	SMBJ110	PD	PD	122 / 149	1.0	110	5.0	3.1	196
SMBG110A	SMBJ110A	PE	PE	122 / 135	1.0	110	5.0	3.4	177
SMBG120	SMBJ120	PF	PF	133 / 163	1.0	120	5.0	2.8	214
SMBG120A	SMBJ120A	PG	PG	133 / 147	1.0	120	5.0	3.1	193
SMBG130	SMBJ130	PH	PH	144 / 176	1.0	130	5.0	2.6	231
SMBG130A	SMBJ130A	PK	PK	144 / 159	1.0	130	5.0	2.9	209
SMBG150	SMBJ150	PL	PL	167 / 204	1.0	150	5.0	2.2	268
SMBG150A	SMBJ150A	PM	PM	167 / 185	1.0	150	5.0	2.5	243
SMBG160	SMBJ160	PN	PN	178 / 218	1.0	160	5.0	2.1	287
SMBG160A	SMBJ160A	PP	PP	178 / 197	1.0	160	5.0	2.3	259
SMBG170	SMBJ170	PQ	PQ	189 / 231	1.0	170	5.0	2.0	304
SMBG170A	SMBJ170A	PR	PR	189 / 209	1.0	170	5.0	2.2	275

NOTES:

- (1) V_(BR) measured after I_T applied for 300μs square wave pulse or equivalent
- (2) Surge current waveform per Fig. 3 and derate per Fig. 2
- (3) For bi-directional types having V_{WM} of 10 Volts and less, the I_D limit is doubled
- (4) For the bi-directional SMBG/SMBJ5.0CA, the maximum V_(BR) is 7.25 Volts
- (5) All terms and symbols are consistent with ANSI/IEEE C62.35

APPLICATION NOTES

These surface mountable packages are designed specifically for transient voltage suppression. The wide leads assure a large surface contact for good heat dissipation, and a low resistance path for surge current flow to ground. These high speed transient voltage suppressors can be used to effectively protect sensitive components such as integrated circuits and MOS devices.

A 600W (SMB) device is normally selected when the threat of transients is from lightning-induced transients conducted via external leads or I/O lines. It is also used to protect against switching transients induced by large coils or industrial motors. System impedance at component level in a system is usually high enough to limit the current to within the peak pulse current (I_{PP}) rating of this series.

RECOMMENDED PAD SIZES

The pad dimensions should be 0.010" (0.25mm) longer than the contact size, in the lead axis.
This allows a solder fillet to form, see Fig. below. Contact factory for soldering methods.

GULL-WING

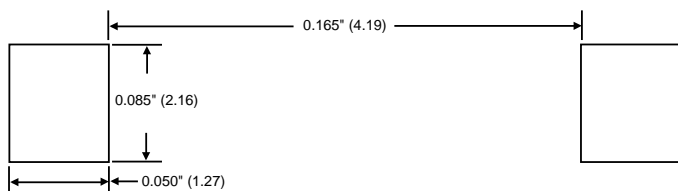

MODIFIED J-BEND

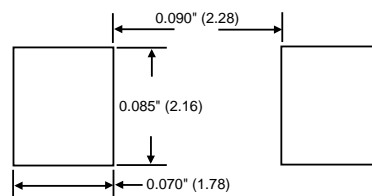

MAXIMUM RATINGS AND CHARACTERISTIC CURVES SMBG AND SMBJ5.0 THRU 170CA

FIG. 1 - PEAK PULSE POWER RATING CURVE

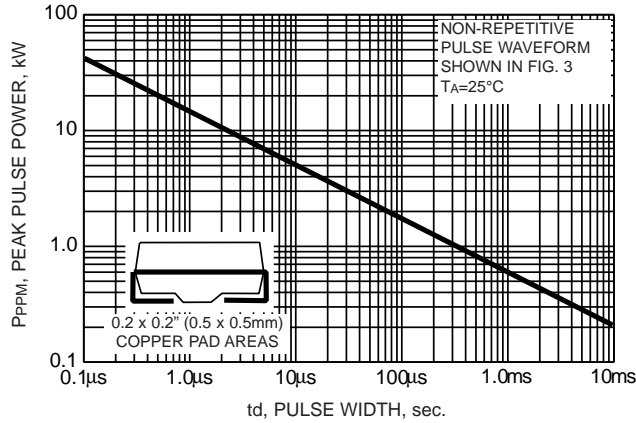

FIG. 2 - PULSE DERATING CURVE

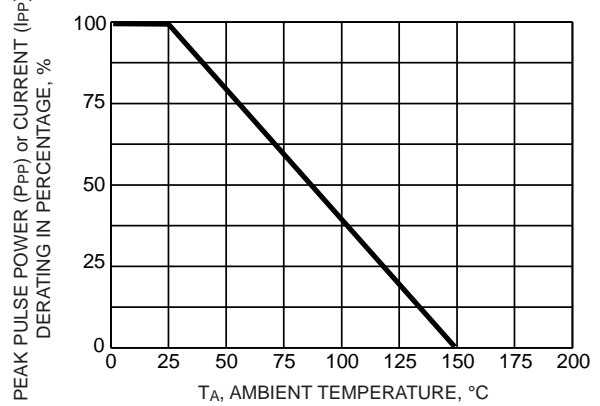

FIG. 3 - PULSE WAVEFORM

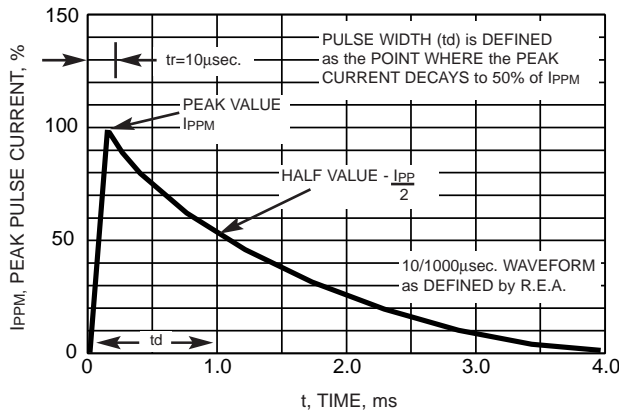

FIG. 4 - TYPICAL JUNCTION CAPACITANCE UNIDIRECTIONAL

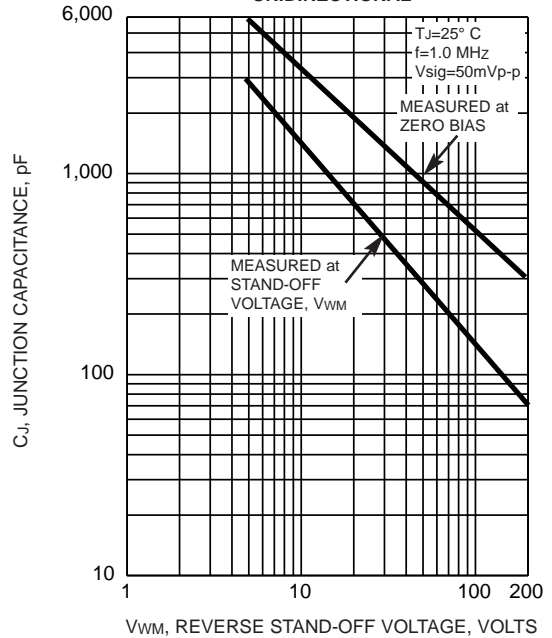

FIG. 5 - TYPICAL JUNCTION CAPACITANCE BIDIRECTIONAL

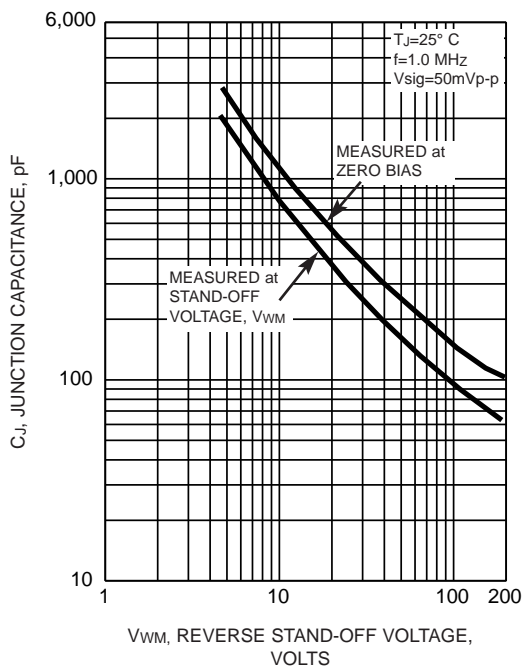
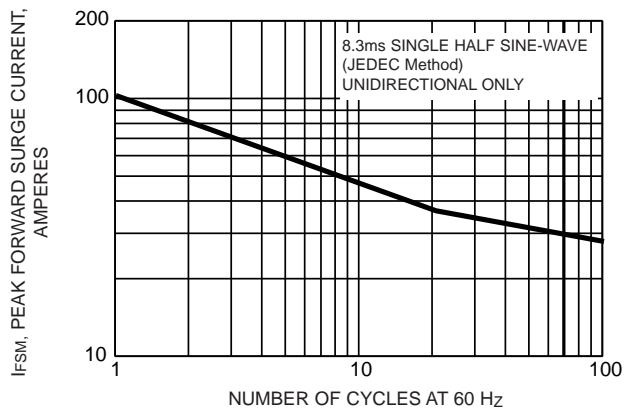

FIG. 6 - MAXIMUM NON-REPETITIVE PEAK FORWARD SURGE CURRENT



This datasheet has been download from:

www.datasheetcatalog.com

Datasheets for electronics components.